





IDEAL



ORION



 Atomizzatore prodotto con ventilatori assiali di diversi diametri, molto versatile è adatto per il trattamento a medio alto volume in numerose coltivazioni.

 High versatile sprayers produced with axial ventilators of various diameters, suitable for medium/ high volume applications on wide cultivation fields

 Atomiseur produit avec ventilateur axial de différents diamètres, d'une très grande polyvalence, adapté pour les traitements à moyen et haut volume sur toutes sortes de cultures.

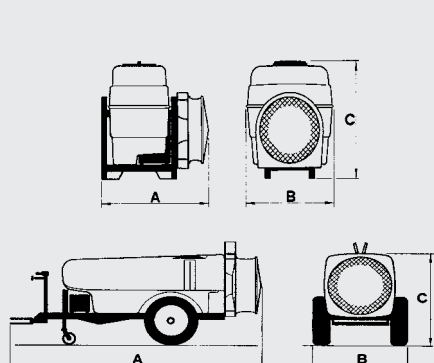
 Zerstäuber mit Axialventilatoren, unterschiedliche Durchmesser erhältlich, vielseitig einsetzbar, geeignet für die Behandlung vieler Kulturen von mittlerem bis hohem Umfang.



	 kW		A	B	C	 Kg
200 P Orion	9	500	1060	840	1050	170
300 PA Orion	11	630	1060	840	1250	175
300 PB Orion	11	630	1100	1000	1070	175
400 PA Orion	13	700	1100	1000	1280	180
400 PB Orion	13	700	1370	1220	1230	240
500 P Orion	13	700	1370	1220	1290	245
600 P Orion	13	700	1370	1220	1420	250
600 T Orion	13	700	2780	1000	1170	420
800 T Orion	13	700	2935	1090	1340	440
1000 T Orion	13	700	3000	1220	1350	500



400 PB ORION



500 P ORION

**Equipaggiamento standard:**

- Telaio e convogliatore zincati a caldo • Assali regolabili in altezza e in larghezza • Moltiplicatore a 2 velocità con folle su trainati, 1 velocità su portati • Serbatoio lavamani • Gruppo di comando sito vicino all'operatore • Filtro di aspirazione con valvola • Pompe a membrana da 50 a 150 lt/min • Doppi getti in ottone con antigoccia • Tubi in PVC • Elica con pale in nylon-vetro • Cisterna in polietilene • Timone regolabile in altezza ed in larghezza • Dispositivo di risciacquo • Raccorderia in ottone • Agitatore idraulico.

**Equipement standard:**

- *Chassis et convoyeur galvanisé à chaud • Essieux réglables • Turbine 2 vitesses et point mort • 1 vitesse sur portés • Lave mains • Distributeur sur tracteur • Filtre à l'aspiration avec clapet de fermeture • Pompe pistons membranes débit 50/150 L/min • Jets doubles laiton avec antigoutte • Tuyauterie PVC • Helice in nylon-vetro • Réservoir en polyéthylène • Attelage réglable • Dispositif de rinçage • Raccord en laiton • Hydro mélangeur.*

**Standard equipment:**

- Hot galvanized frame and conveyor • Hight and width adjustable axles • Two speed overdrive and neutral position on trailed models • One speed overdrive and neutral position on mounted models • Hand-washing tank • Central control system at the tractor cab • Suction filter with valve • Diaphragms pump from 50 to 150 L/min • Anti-drip brass double jets • PVC pipes • Nylon-vetro popeller • Polyethylene tank • Adjustable draw-bar in height and in length • Circuit rinsing device • Brass fitting • Hydraulic stirrer.

**Standardausrüstung:**

- *Feuerverzinkter Rahmen • Feuerverzinktes Ventilatorgehäuse • In Höhe und Breite verstellbare Achsen • Zweigang-Getriebe mit Leerlauf bei gezogenen Modellen • Handwassertank • Für den Bediener günstig angebrachte Bedienungseinheit • Saugfilter mit Abstellventil • Membranpumpen von 50 bis 150 l / min • Anti-Tropf Messing-Doppeldüsen • PVC Schläuche • Propellerflügel aus Glasfibrerkunststoff • Polyäthylentank • In Höhe und Breite verstellbare Deichsel • Zusatzwasser Spültank • Messinganschlüsse • Hydraulischer Mischer*